

MONDO TAŞ TABANLI PİZZA FIRINI

MONDO STONE-BASED PIZZA OVEN



FİMAK[®]
Fırın ve Gastronomi Makinaları
Bakery and Gastronomy Machines

MODEL	PİZZA MONDO - E (Elektrik-Electrical)		PİZZA MONDO - G (Doğalgaz-Natural Gas)	
	PİZZA MONDO-E X 1	PİZZA MONDO-E X 2	PİZZA PFG-4 MONDO-G X 1	PİZZA PFG-4 MONDO-G X 2
Kapasite (Pizza Adedi / 1 saat) Capacity (Loaves of Pizza / 1 hours)	36	72	36	72
Pişirme Alanı (m ²) Baking Surface (m ²)	0,5	1	0,45	0,9
Kat Sayısı Number of Decks	1	2	1	2
Fırın İç Geniřliđi (mm) Inner Width of Oven (mm)	720	720	688	688
Fırın İç Derinliđi (mm) Inner Depth of Oven (mm)	720	720	670	670
Fırın İç Yüksekliđi (mm) Inner Height of Oven (mm)	150	150	186	186
Geniřlik - A (mm) Width - A (mm)	1060		1080	
Derinlik - B (mm) Depth/Length - B (mm)	965		1000	
Yükseklik - C (mm) Height - C (mm)	440	880	535	1075
Max. Derinlik - D (mm) Max. Depth/Length - D (mm)	1040		1120	
Max. Yükseklik - E (mm) Max. Height - E (mm)	480	920	1060	1610
Max. Sehpalı Yüksekliđi - F (mm) Max. Height - F (mm)	1330	1770	1920	2455
Davulmbaz Altı Min.Çalıřma Yüksekliđi - G(mm) Peak Height - G (mm)	1480	1920	2070	2605
Min. Tavan Yüksekliđi - H (mm) Min. Ceiling Height - G (mm)	1780	2220	2370	2905
Elektrik Gücü (kw) Electrical Power (kw)	5,2	10,4	1	2
Elektrik Bađlantısı Electrical Connection	3P + N + PE		1P + N + PE	
Max. Sıcaklık (°C) Max. Temperature (°C)	400		400	
Ort. Yakıt Tüketimi (8 saat) (kw/h) Average Consumption (8 hours) (kw/h)	2,74	5,48	1,6	3,2
Baca Çıkıř Çapı (mm) Chimney Outlet Diameter (mm)	-		Ø155	
Fırın Ađırlıđı (kg) Weight of Oven (kg)	160	320	194	386
Enerji Kaynakları Source of Energy	Elektrik/Electric		Doğalgaz/Natural Gas	
Kontrol Sistemi Control System	Dokunmatik/Touch			

Ön Görünüş
Front View

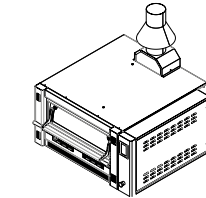
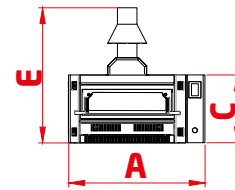

PİZZA MONDO - G

Perspektif Görünüş
Perspective View

Sol Yan Görünüş
Left Side View

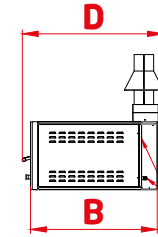

1/2" Bađlantı Gaz Giriři
1/2" Natural Gas Inlet Pipe

PİZZA MONDO DOĐALGAZLI
Şebeke : 230 V 50Hz
Elektrik Gücü : 0,1 kw
Kablo : 3 x 1,5 mm²
1 Adet 1x4A Sigorta

PİZZA MONDO NATURAL GAS
Network : 230 V 50 Hz
Electrical Power : 0,1 kw
Cable : 3 x 1,5 mm²
1 Piece 1x4A Fuse

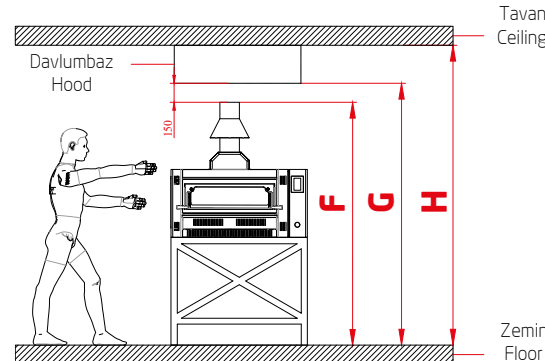

Ön Görünüş
Front View

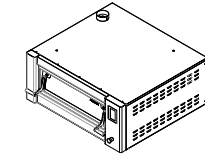
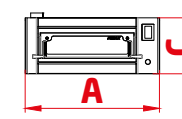

PİZZA MONDO - E

Perspektif Görünüş
Perspective View

Sol Yan Görünüş
Left Side View

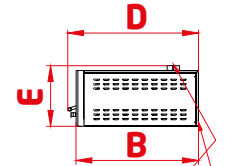

Baca Çıkıřı : Ø100 mm
Chimney Output : Ø100 mm

PİZZA MONDO ELEKTRİKLİ
Arkadan Giriřli
Şebeke : 380 V 50 Hz
Toplam Elektrik Gücü : 5,2 kw
Kablo : 5 x 2,5 mm²
1 Adet 3x16A Sigorta

PİZZA MONDO ELECTRICAL
Behind Entry
Network : 380 V 50 Hz
Total Electrical Power : 5,2 kw
Cable : 5 x 2,5 mm²
1 Piece 3x16A Fuse

